

HAND TELEPHONE SETS — 202E, F, G, H
LOCAL BATTERY — CONNECTIONS

1.00 INTRODUCTION

This section covers the combination of apparatus, circuit diagram, and connections for the 202-type hand telephone sets for local battery talking—common battery signaling service.

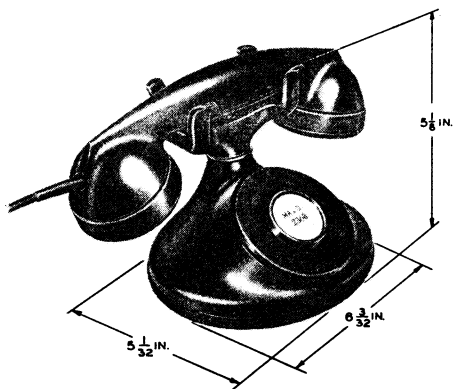

FIG. 1—202 TYPE MANUAL

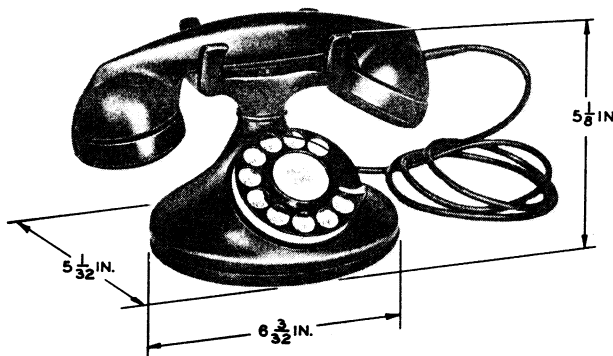

FIG. 2—202 TYPE DIAL

TABLE A—COMBINATION OF APPARATUS

Hand Tel. Set Code	Components					Note
	Handset	Handset Mounting	Dial or Apparatus Blank	Handset Cord	Mounting Cord	
202E-3E	E1E-3	D1-3	4HA-3 or 5HA-3	H3	D4	1, 2, 3, 4
202E-3F	F1A-3, F1G-3, or F4A-3					
202F-3E	E1E-3		4HB-3, 5HB-3, or 6A			
202F-3F	F1A-3, F1G-3, or F4A-3					
202G-3E	E1E-3		4HC-3 or 5HC-3			
202G-3F	F1A-3, F1G-3, or F4A-3					
202H-3E	E1E-3		50J-3 or 94A-3			1, 2, 4
202H-3F	F1A-3, F1G-3, or F4A-3					

Notes

- Codes listed are for apparatus with black finish. For apparatus finished in other colors, the dash number (-3) is changed to the code number for the particular color.
- The letter in the hand telephone set code number denotes whether set is manual or dial, and type of dial number plate when dial.
- May be equipped with 61N filter.
- When the handset is equipped with spring cord, the suffix R will be added to the set code. For example, a 202F-3F becomes a 202FR-3F.

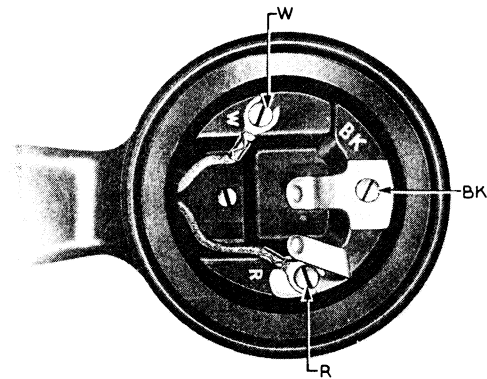

FIG. 3—F1 AND F4-TYPE HANDSET

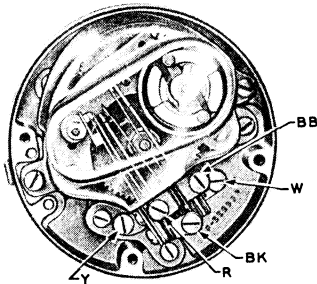

FIG. 4—6A DIAL

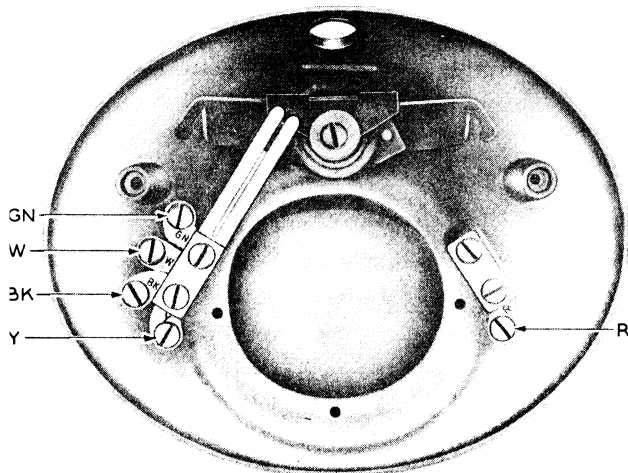

FIG. 5—D1-3 HANDSET MOUNTING

ASSOCIATED APPARATUS

		Class of Service	Sub. Set
TABLE B	Individual Lines		634Y, YD
	PBX Stations		
	2-Party Flat Rate		
	2-Party Message Rate (Manual and Ring Party Dial)		
	4-Party Semiselective		
	Multiparty Divided Code		
Multiparty Nonselective			
4-Party Selective		634YT, YDT	
8-Party Semiselective			

2.00 GENERAL

2.01 The 634YD or 634YDT subscriber set should be used if hand telephone set is equipped with F-type handset.

2.02 Hand telephone sets equipped with E-type handsets may be used with any of the above subscriber sets providing their use does not conflict with transmission zoning requirements.

2.03 When hand telephone sets equipped with E-type handsets are used with the 634Y or 634YT subscriber sets, the 557B or 574A receivers shall be tested and connected for proper polarity, as follows:

- After all connections have been made, remove the receiver cap and check the magnetic pull on the diaphragm. Reverse the line-wire connections on L1 and L2 of the subscriber set and recheck the magnetic pull. Restore connections of line wires to normal.
- The magnetic pull on the diaphragm should be greatest with the line wires normal. If not, make the following changes in the subscriber set.
 - a. Remove BK lead from L1 and connect to L2GN.
 - b. Remove GN cord lead from L2GN and connect to L1.

CIRCUIT DIAGRAM

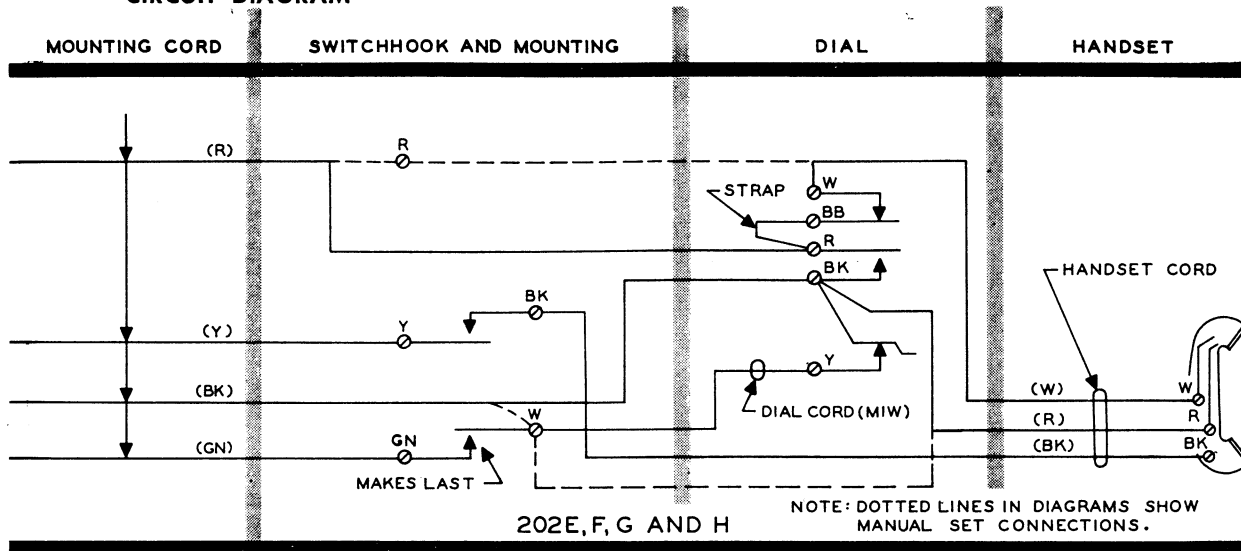

3.01 When filters are required for radio-frequency suppression, equip the hand telephone sets with 61N-type filters connected as shown. Removal of the M1W cord between the Y terminal of dial and the W terminal of switchhook is required when filter is provided.

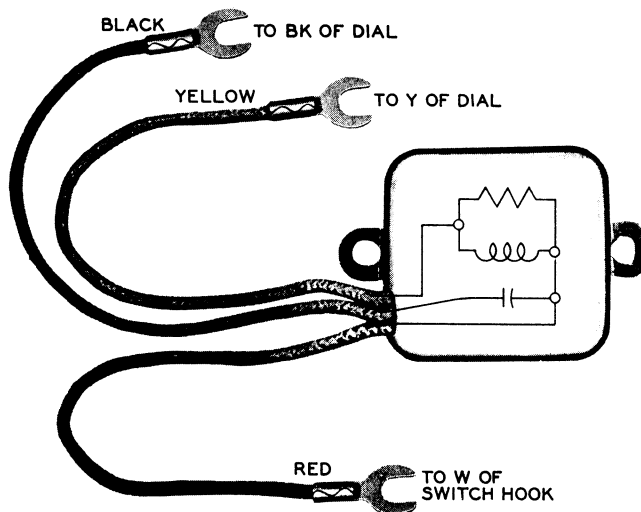

FIG. 6—61N FILTER CONNECTIONS